

12.1" Capacitive Touch PC



- Intel® Celeron™ QuadCore J1900 CPU
- 4GB RAM (expandable to 8GB)
- 64GB faytech Industrial SSD
- Supports Win7/8/10, Linux (32Bit, 64Bit)
- Reinforced front glass, anti-glare surface treatment
- Extensive industrial and consumer interfaces
- 10-Finger-Multi Touch Capacitive Touch Panel
- Patented IP65 front with silicon seal
- Audio amplifier with speakers
- VESA 100 Mounting
- Integrated W-LAN
- 2 years guarantee



faytech's Capacitive PC series stands out among competition with its fanless silent operation, IP65 front panel design, high reliability and fine craftwork.

It is the perfect choice for industrial and business application. It has flat edge to edge glass with IP65 water- and dust proof front panels. The back has a sturdy aluminum case manufactured out of a continuous casting mold with stable VESA 100 fixation bolts (VESA-400 for 32" and up). The PCs offer numerous industrial and consumer connectors such as four serial ports, eight GPIOs and USB 3.0.

The heart of the Touchscreen PC is faytech's industrial fay-002 mainboard with the powerful Intel® Celeron™ J1900 QuadCore processor with up to 2.42GHz Core speed, equipped with 4GByte RAM, 64G SSD and Intel's HD Graphic chipset, supporting FullHD, DirectX 11.1 and OpenGL 4.0.

These faytech PCs are the perfect choice for a wide variety of applications including POS systems, control panels in industrial fields, in kiosk systems, office/residence automation, digital signage and in areas like shopping malls, classrooms, hotels and many more.

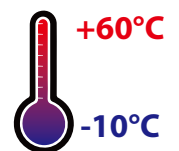

Product name	12.1" Capacitive Touch PC
Model No. / EAN No.	FT12J1900W4G64GCAP / 6920734012534

IP Rating	
IP65 Front / IP40 Back	

LCD Panel	
Screen diagonal (Inch/cm)	12.1/30.73
Display active screen size	24.60×18.40
Aspect ratio	4:3
Physical resolution	1024×768
External Maximum showable resolution - DP, VGA	1920×1200
Colours displayed	16.7M
Brightness (cd/m ²)	500
Contrast	700:1
Typical reaction time Tr/ Tf (ms)	25/10
Visual Angle horizontal/vertical (°)	160/160
Backlight / Backlight Lifetime (hours)	LED / 30,000

Operation / Mechanical	
Operating Temperature (°C)	-10 ~ +60
Humidity Range (RH)	10% - 90%
Net weight (kg)	3.50
Gross weight (kg)	5.50 (incl. cartonage)
Housing material	Rubber front case, Aluminum IPC back case
Housing (cm) L × W × H	30.86 × 23.91 × 5.38
Mounting	VESA 100

Internal Connectors	
1x SO-DIMM Slot, max. 8GB, DDR3L-1333 Single channel memory	
1x 12V DC power connector (2-pin); 1x 4-pin SATA power connector	
2x S-ATA 3GB/s ports; 1x VGA pin header; 1x LVDS connector	
1x 5-pin LCD power connector; 1x SIM-card-Header (connected to MiniPCle)	
1x S/PDIF output pin header; 1x 4-pin (2x2W) audio amplifier connector	
1x PS/2 keyboard/mouse connector (6-pin); 1x 8-bit Digital I/O interface	
2x USB 2.0 header supports additional 4x USB 2.0 ports; 1x Chassis Fan connector	
3x RS232/RS485 COM connectors, switchable between RS232/RS485 in BIOS	

PC System	
CPU	Intel® Celeron™ QuadCore J1900
Chipset	Intel® E3800
Graphic GPU	Intel® HD Graphics
Audio	Realtek 887 8 -channel high definition audio codec, Audio Amplifier EUA 2012A
Memory	1x 4GB DDR3L SODimm (expandable to 8GB)
Storage	faytech Industrial 64GB SSD
Network	2x Realtek PCIe GB LAN 8111G; W-LAN
Driver Support	Win7/8/10; Linux; 32Bit/64Bit
Preinstalled OS	Linux Ubuntu

Touch Panel	
Touch Technology	Projected Capacitive 10-Point Multitouch
Touch Connector	USB
Touch Life (Contacts)	Unlimited
Surface Hardness	7H
Surface Treatment	Anti-glare (chemical etched)

Power	
Power Indicator	Green LED
Power Supply	100-240V ACDC active switching; 12V DC-Out
Working Power (V)	12
Power Consumption (W)	15
Stand-By Consumption (W)	<1

External Connectors	
1x 12V DC-In (screwable)	
1x DisplayPort	
1x VGA-out (from internal header)	
1x USB 3.0, 3x USB 2.0 ports	
2x COM port Full-PIN (RS232/485; 5V/12V)	
2x COM port 3-PIN (RX, TX, GND; RS232/485 switchable)	
2x 10/100/1000Mbit RJ45 Ports	
2x W-LAN connector	
1x S/PDIF-Out (1x Cinch, 1x Torx module)	
1x MIC-In & EAR-Out	
8x In/Out GPIO as RJ45	
1x 2.5" module slot, changeable SSD included	

Expansion slots	
2x Mini Card slots with PCIe and USB interface (2x Full Height/Half height changeable)	
1x PCIeX1 Straddle Connector	

Included in the Delivery	
Power Supply (see Power section)	
W-LAN antenna	
Short Installation Manual	
Standard Stand	

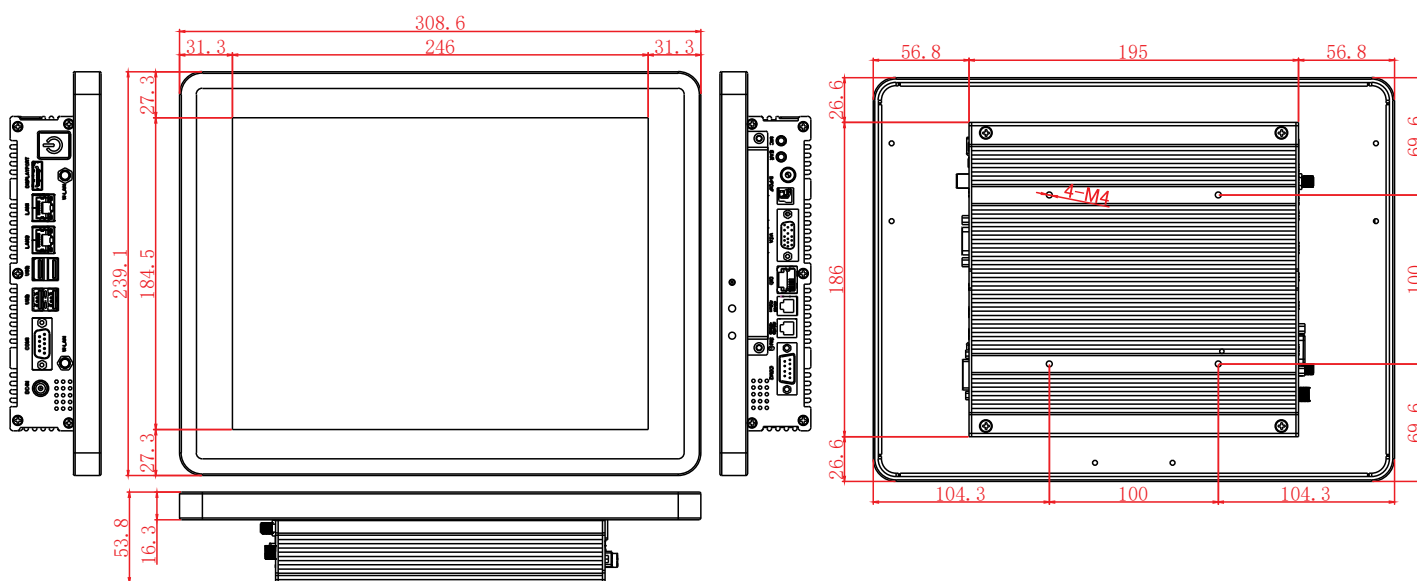

Corporate Headquarters

faytech AG
 Bischhäuser Aue 10
 37213 Witzenhausen
 Germany

support@faytech.com
contact@faytech.com
www.faytech.com

China: +86 755 8958 0612
 Germany: +49 5542 30374 10
 USA: +1 646 205 3214
 India: +91 11 49707436
 Japan: +070 4127 5167